



VI. 1

--
--
--

KE G(80 110) KIL4



5



75



AC

AC



IV



RECI(80 110)KL4

2

05

	-		
			6
			5

1	6
1 1	6
1 2	7
1 3	7
1 4	8
2	10
2 1	10
2 2	10
2 3	11
2 4	13
2 5	13
3	16
3 1	16
3 2	16
3 3	19
3 4	21
4	24
4 1	24
4 2	24
5	25
5 1	25
5 2	27
6	29
7	31
8	32

1

1.1

T

1

▪ 98.7%

▪ 1.5 20A

▪ 1100V

▪ 45

▪ HD

2

▪ AP

3

▪ IR66

4

▪ I-V

▪ HC ()

5

-
-
-

PF QU

12

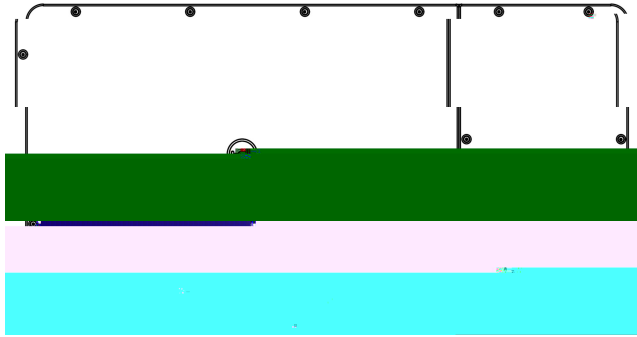

13

KE CT10K14

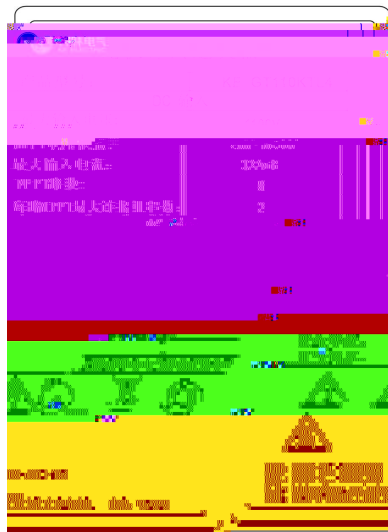

14

	KE G8KIL4	KE G10KIL4	KE G11KIL4
	12kW	15kW	16kW
	110V		
	180V		
	580V		
NPT	200V 100V		
NPT	6	8	8
NPT	2	2	2
	32*6	32*8	32*8
	50*6	50*8	50*8
	8kW	10kW	11kW
	88A	110A	121A
	3 128A	3 160A	3 176A
	3/NBE, 400V		
	30V 48V		
	50Hz		
	45Hz 55Hz		
	0.9 0.8 0.8		
	3%		
	0.5%		
	98.70%	98.70%	98.70%
	98.10%	98.10%	98.10%
	98.10%	98.10%	98.10%
RD			
	II		

ACI					
HD					
mm	120 535 275		140 810 500		
(kg)	65	67	73	75	82 84
	IR86				
	1W				
	-30 60				
	0 100%				
	70dB				
	400m		200m		
	LED				
	RS485				
	4G				

2

21



22

1		1	
2		1	
3		4	MDSM2 10 MDM2
5		12 / 16	
6		1	
7		1	
8		1	

21





23



21

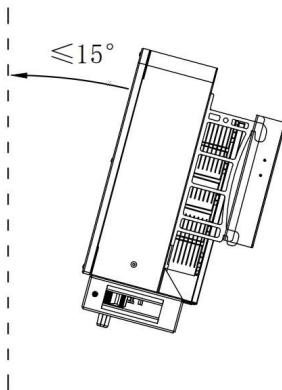
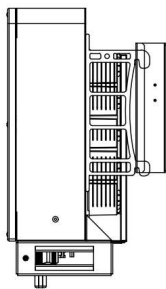

22

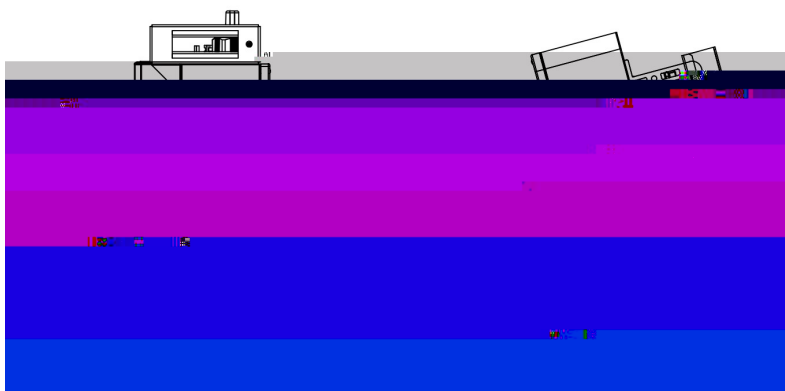

23

IR86

15



24

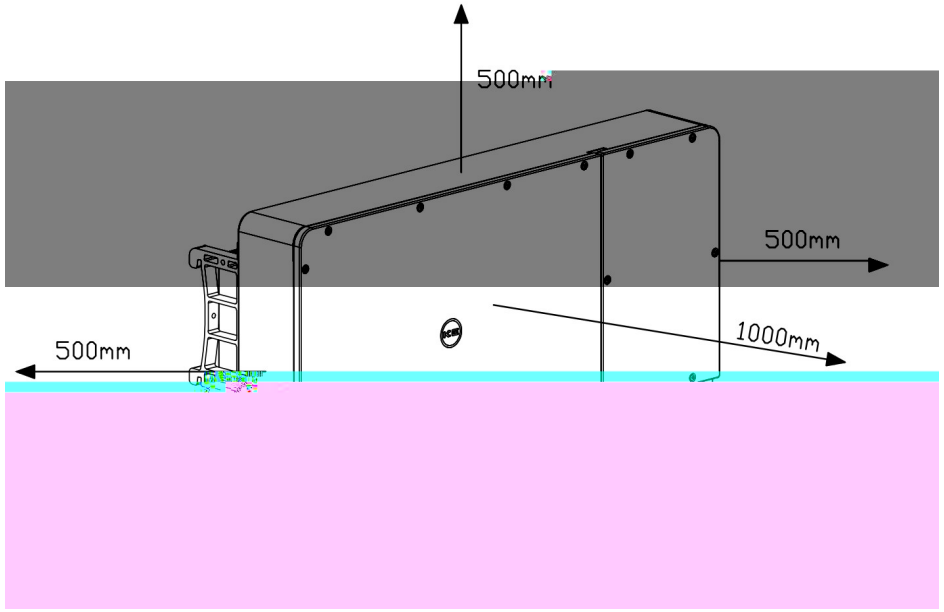

23

75

-250

50mm ,

50mm

25

- ☞
- ☞
- ☞

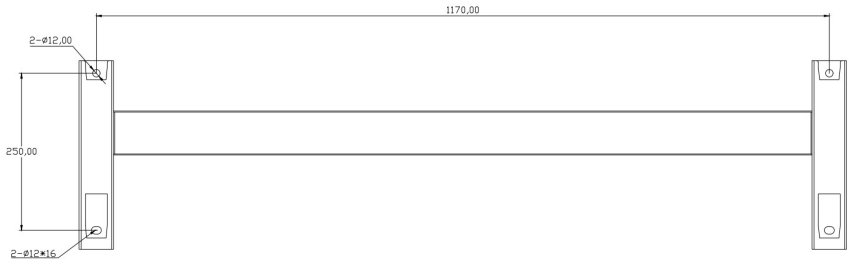

24

1

2

3

90mm

25

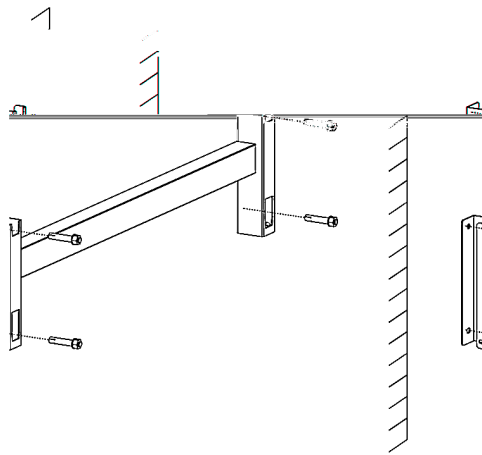

25

4

26

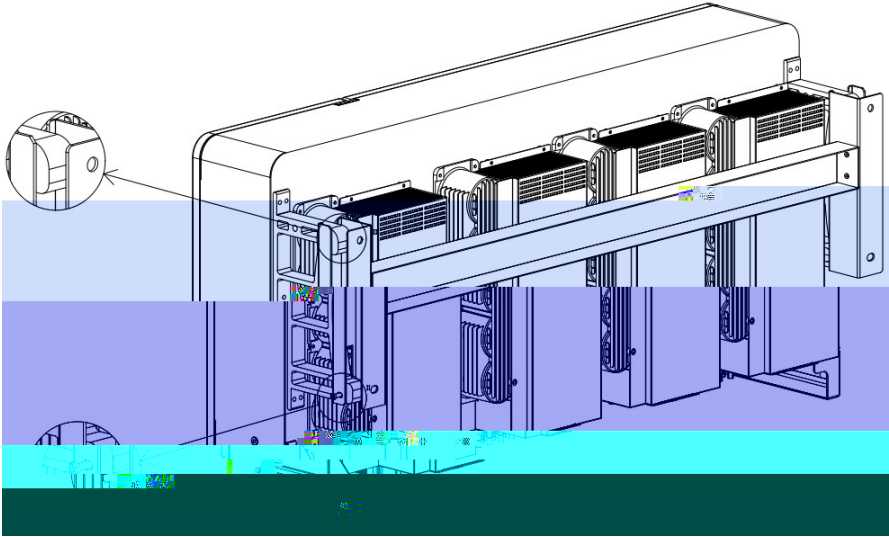

26

5

30

27

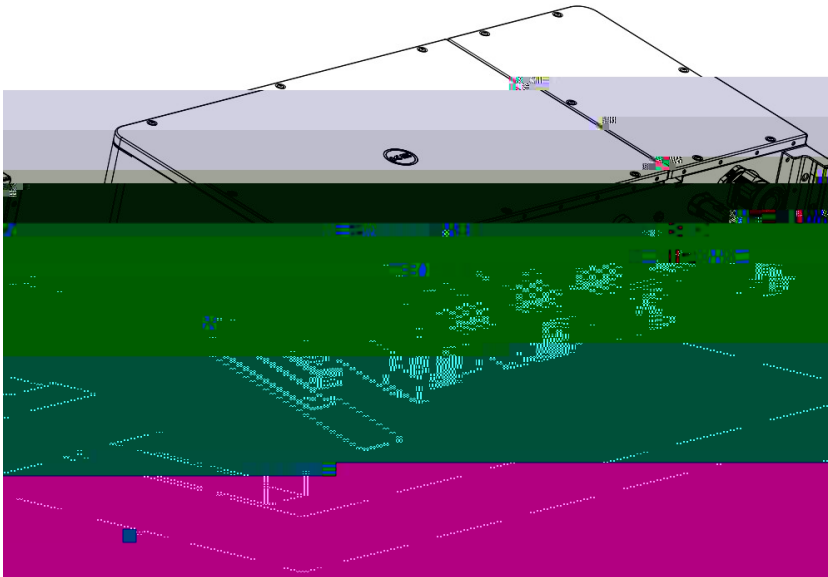

27

3

3 1

REG(80 110)HL4

3 1

+	
-	
D1	1
D2	2
D3	3
D4	4
D5	5
D6	6
D7	7
D8	8
USB	
RS45	

3 1

1

2

3

4

3 2



31

1

7m

31

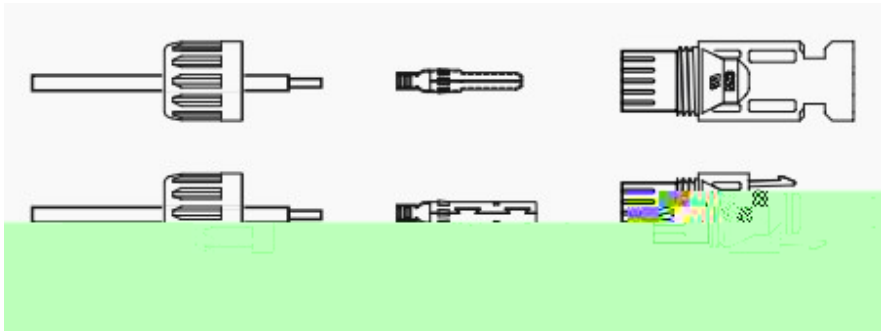

31

2

32

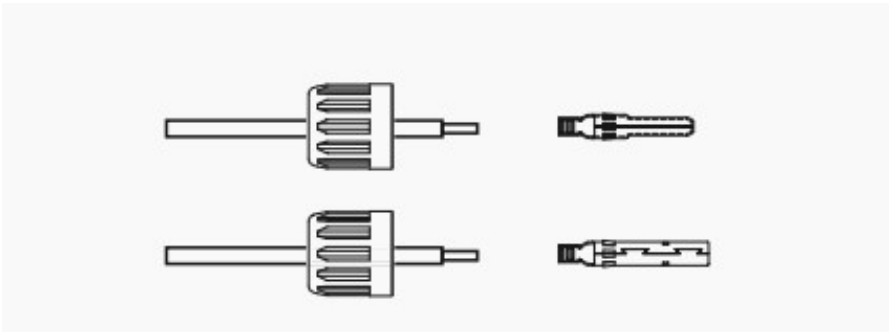

32

3

33



33

4

34m

34

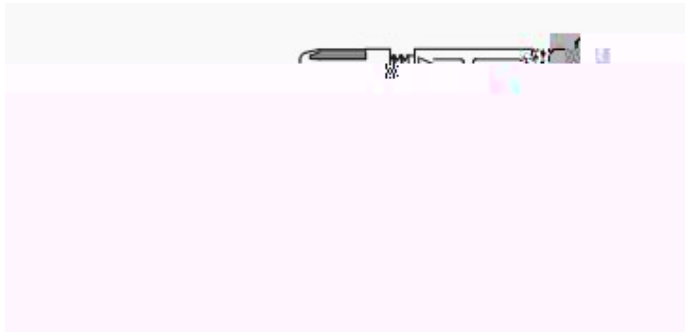

34

5

IV

(35)

36

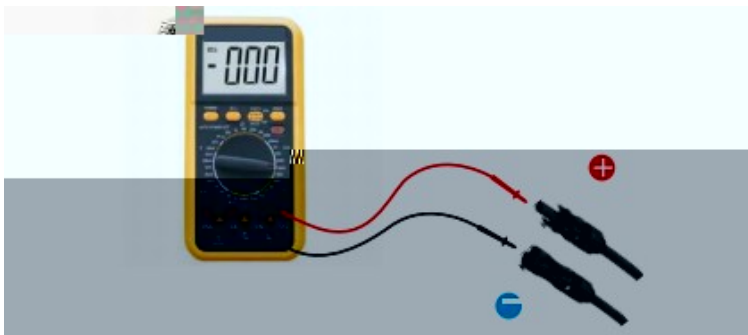

35

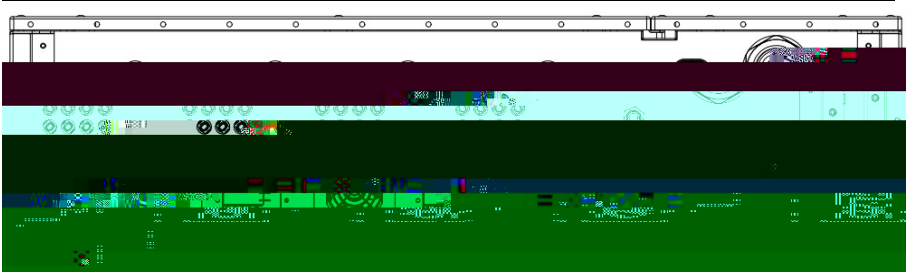

36

	mm		mm
PVI-F	40-60 (12-10A)	40 (12A)	55-90

33

KE C(80 110) KIL4

50 70 105 C

1.5dm

			/
mmf		50 70	80 94
		50	80
mm		47 57	
		52	



1

90mm

,

37

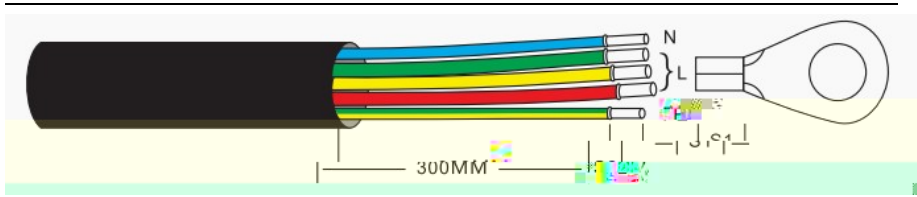

37

2

CT

CT

3

4

4

(38)

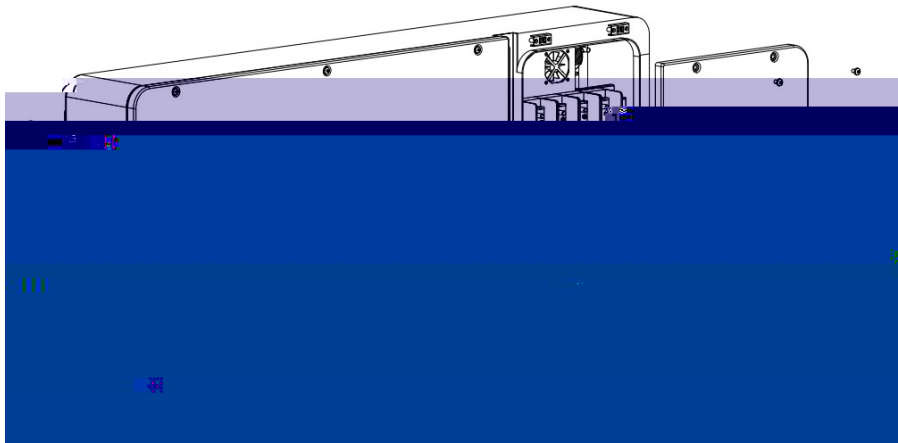

38

5

10 2N(39 310)

6

4-70

20m

7

10 20N(39 310)

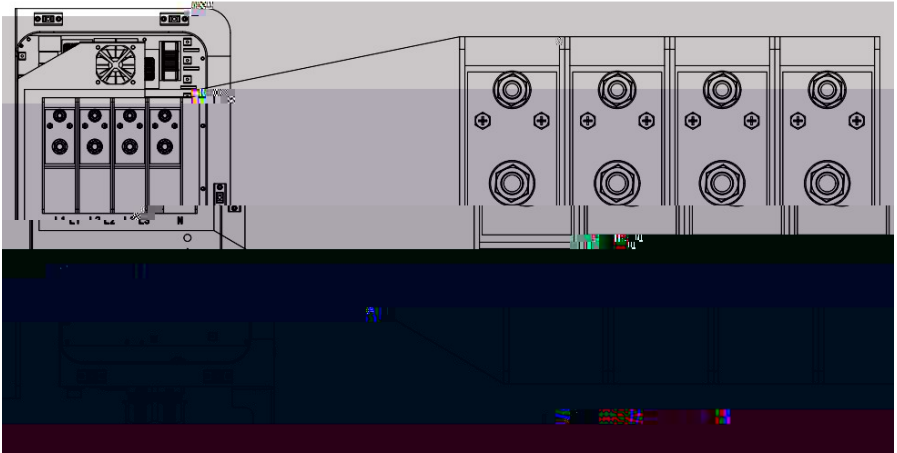

39

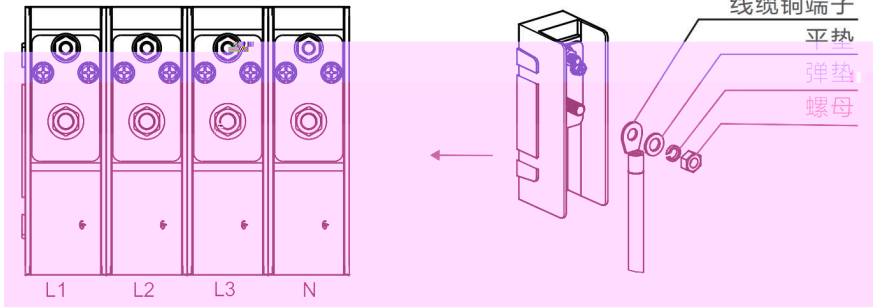

310

34

1



重要:
对于并联的多个逆变器，所有逆变器应连接到同一接地点，以确保接地线等电位连接。

3

3 11)

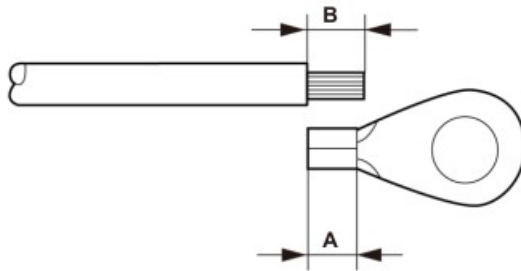

3 11

A (OT 线缆端子压接区域) 长2mm~3mm。 P (绝缘剥高长度)

4

CT

3 12

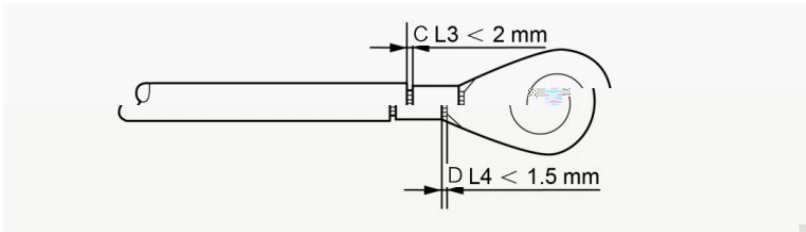

3 12



重要:

将端子压接到线缆后，检查连接以确保端子牢固地压接到线缆上。

5

6

10 12Nm

3 13

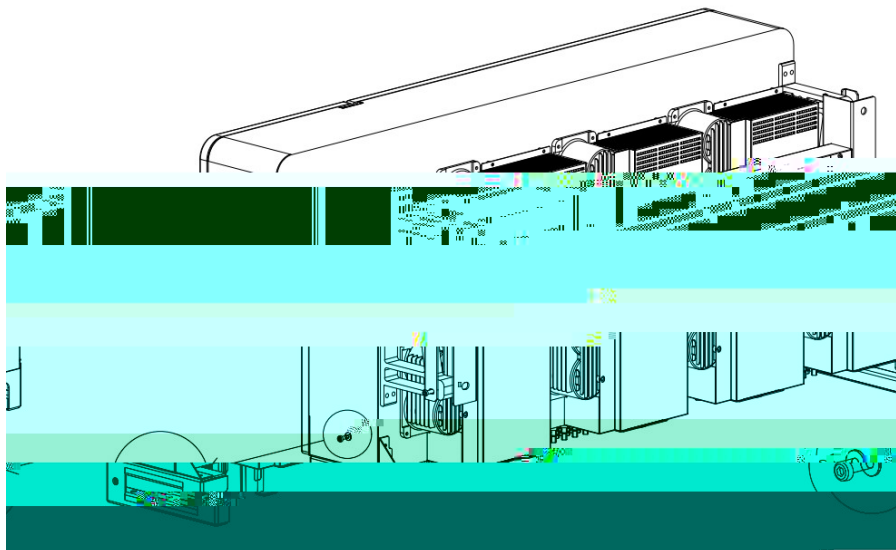

3 13



重要:

为提升防腐性能，安装接地线后，建议涂上硅胶或涂料。

4

41

IE AC
IE AC
AC

42

1
2
3

1
2

30

IED

30

5

51

AP



51

AP

AP

32



52



“ ” “ ” “ ” “ ”

“ ”

“ ”



54

52

http://solar.ke-energycloud.com:8301/energycloud_solar/#

55



55

56



56

7

☞

5

☞

☞

☞

☞

☞

☞

☞

☞

☞

☞

☞

☞

☞

☞

☞

8

:

: **0086 311 85231078 400 0811 128**

: **0086 311 85231087**

: **[http //www.sd.arla.com/](http://www.sd.arla.com/)**