





▪

▪

▪

▪

▪

▪

▪

▪

▪

▪

▪

▪

▪



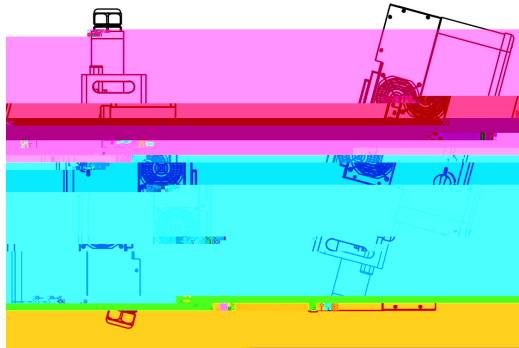
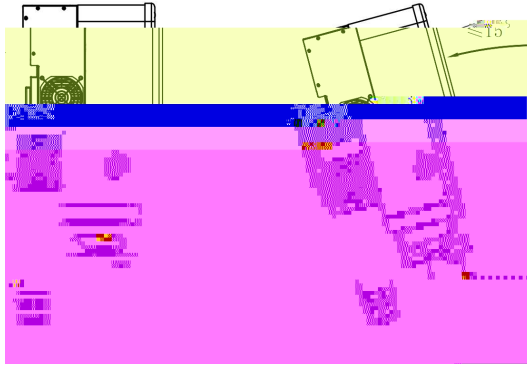

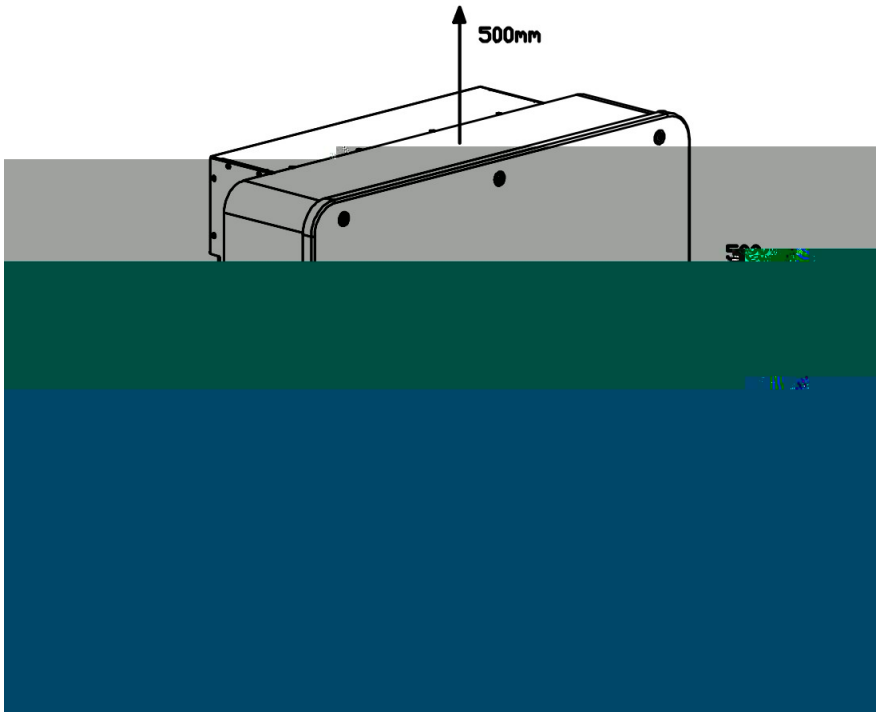

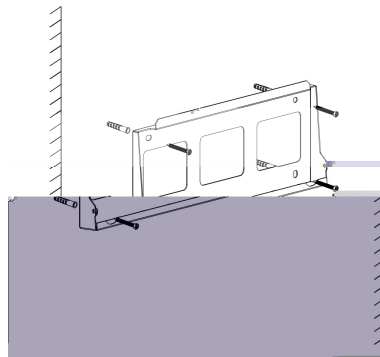
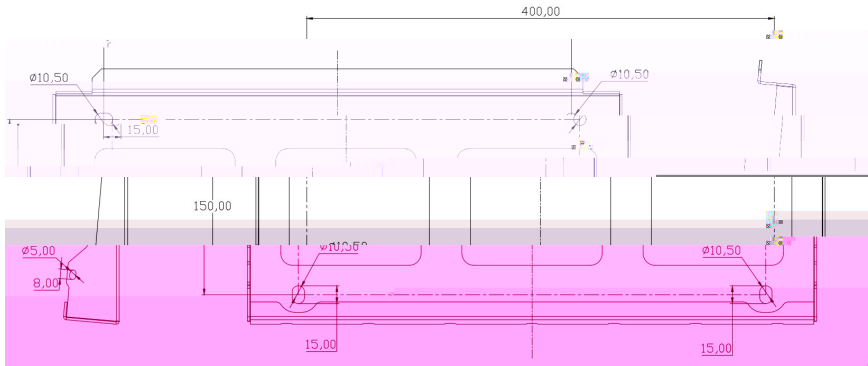

☞

☞

☞

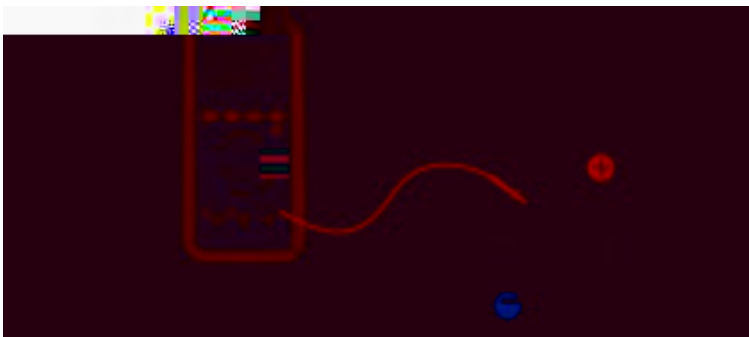
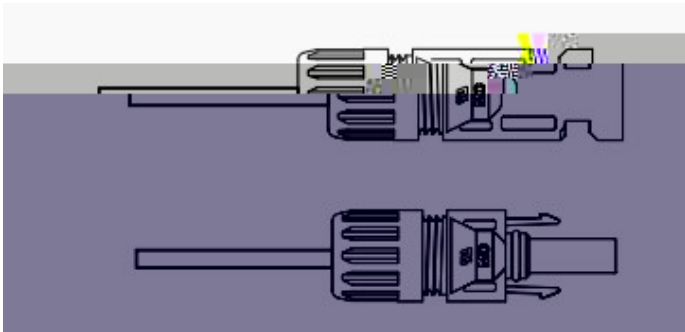

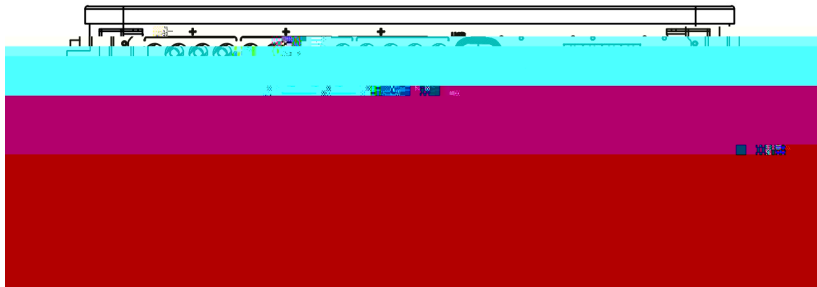



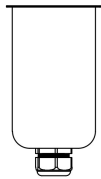
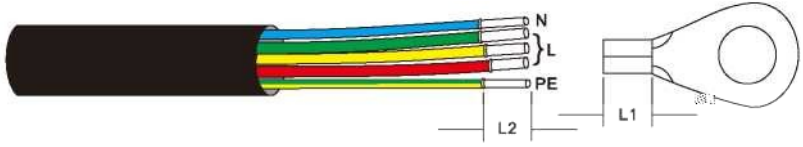

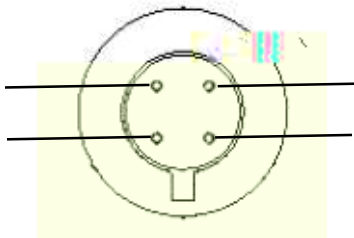
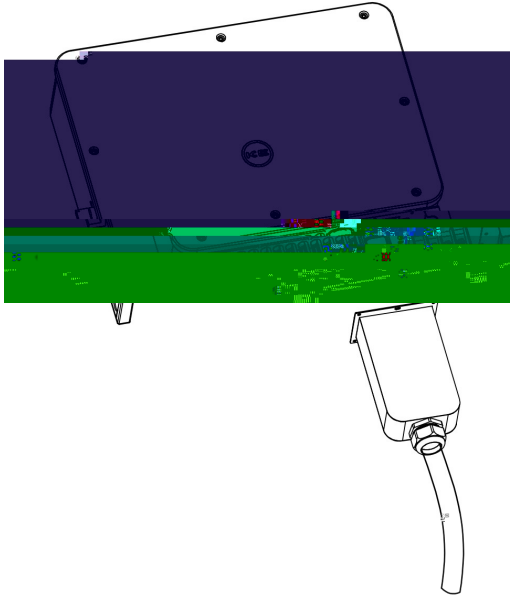



重要:

对于并联的多个逆变器，所有逆变器应连接到同一接地点，以确保接地线等电位连接。

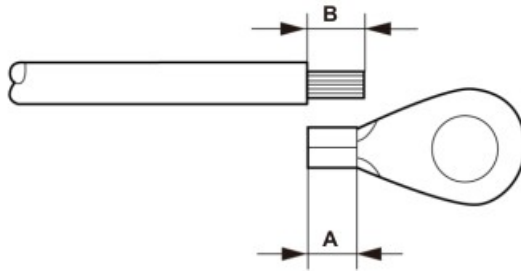

重要:

P (OT 剥壳长度) 比 A (OT 线缆端子压接区域) 长 2mm~3mm。

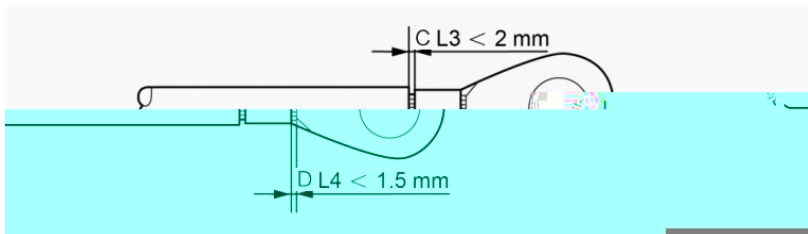

重要:

将端子压接到线缆后，检查连接以确保端子牢固地压接到线缆上。

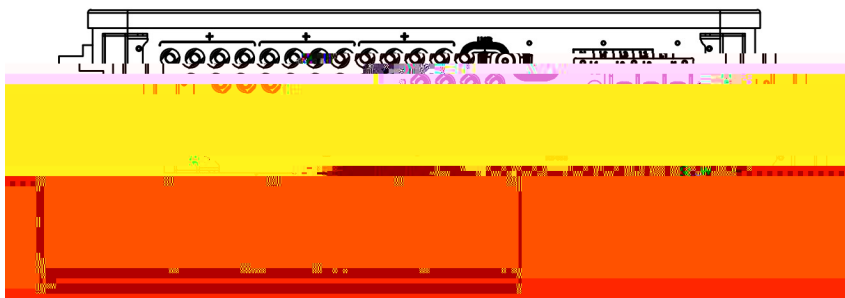

重要:

为提升防腐性能，安装接地线后，建议涂上硅胶或涂料。

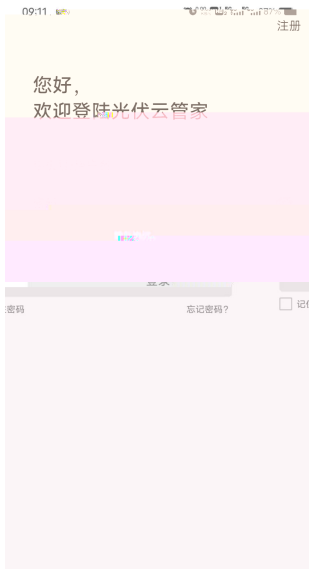



智慧光伏监控运维系统

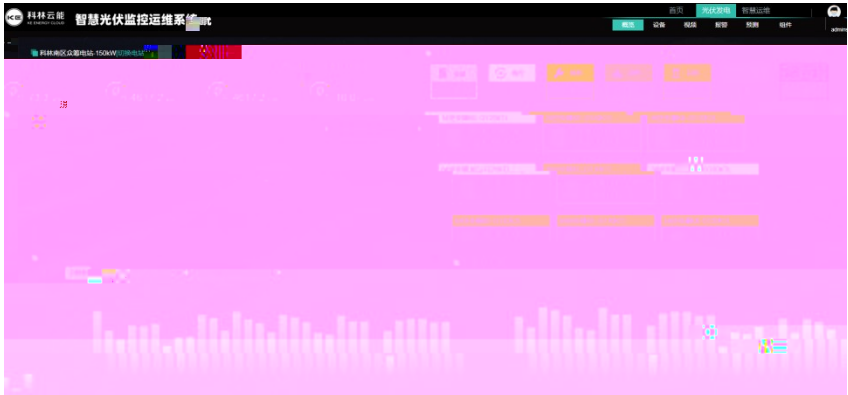

☞

☞

☞

☞

☞

☞

☞

☞

☞

☞

☞

☞

☞

☞

☞

☞

☞

☞

