

VL 2

--

--

--

KE G(304) K14

VI 0	2023 08 24	
VI 1	2023 12 06	
VI 2	2025 08 31	



5



75



AC

AC



IV



▼

IE C(304)R14

2

05



6

5

1	6
1 1	6
1 2	6
1 3	7
1 4	8
2	10
2 1	10
2 2	10
2 3	11
2 4	13
2 5	14
3	16
3 1	16
3 2	16
3 3	19
3 4 RS485	21
3 5	22
4	24
4 1	24
4 2	24
5	25
5 1	25
5 2	27
6	29
7	32
8	33

1

1.1

T

1

▪

98.7%

▪

1.5

20A

▪

1100V

▪

45

2

▪

AP

▪

3

▪

▪

▪

IR66

4

▪

▪

5

▪

▪

PF QU

12

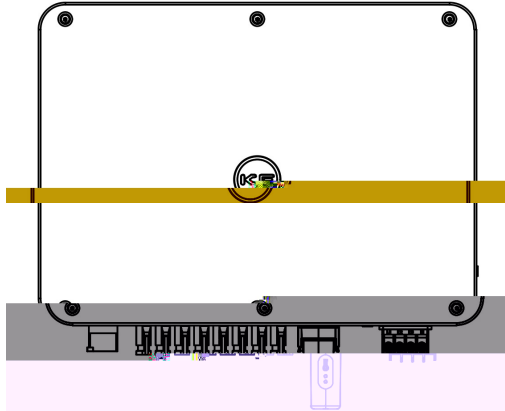

13

KE G20K14

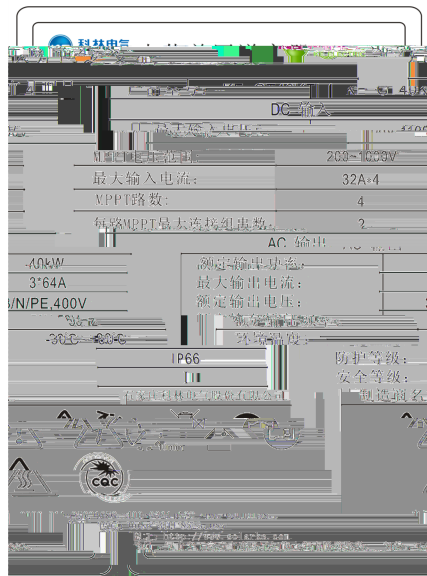

	7	
	92	22
	2	722
	25	
	0222	4222
		D
	R041	4
	0	
	R2224	4270
		94220 4274

2

21



22

1		1	
2		1	
3		2	
4		6	
5		68	30/3kW 6 36/4kW 8
6		1	
7		1	
8		1	

21





23



21

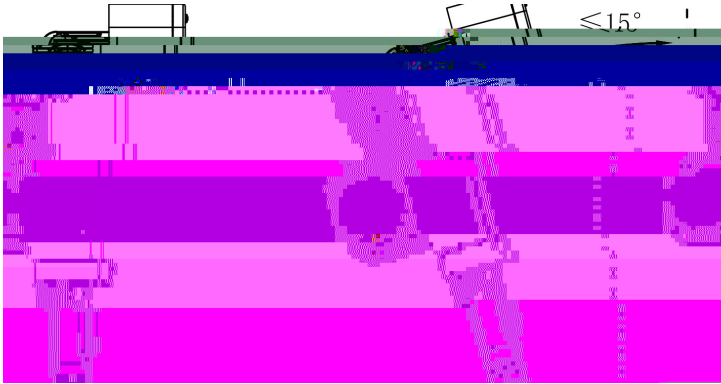

22

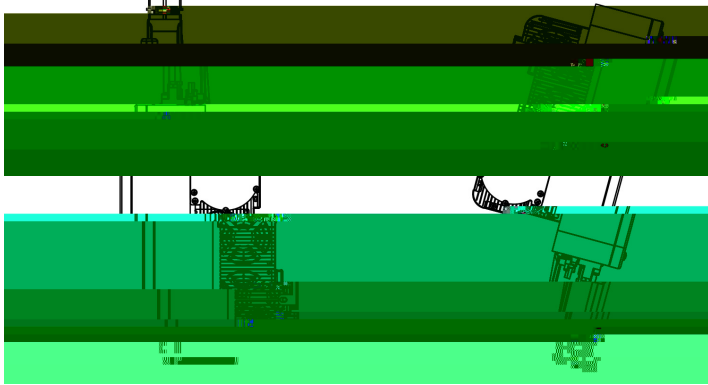

23



IR66



15



IED





24

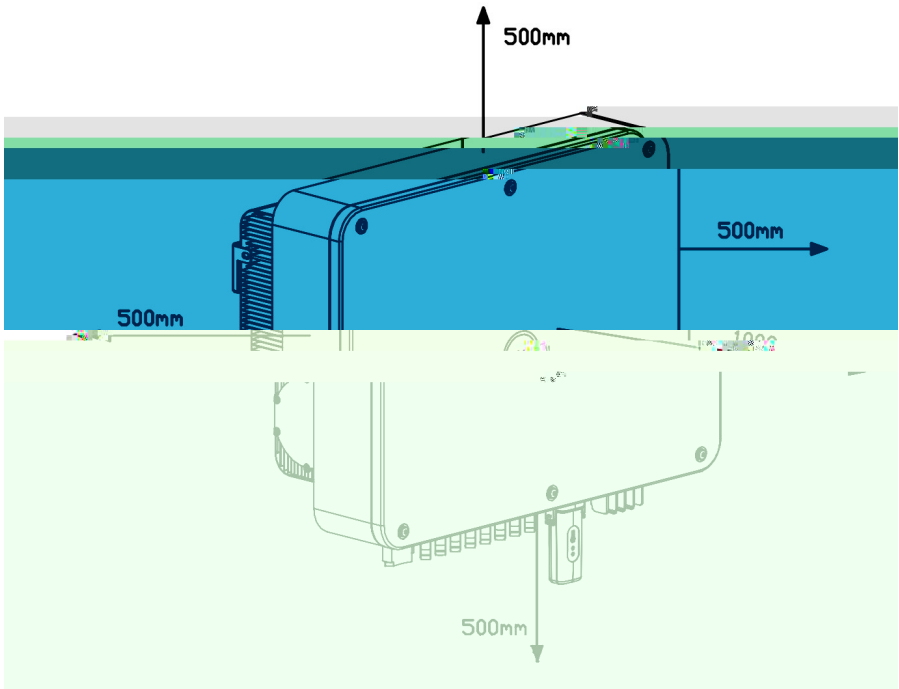

24

75

- 30 60

500mm ,

500mm



25

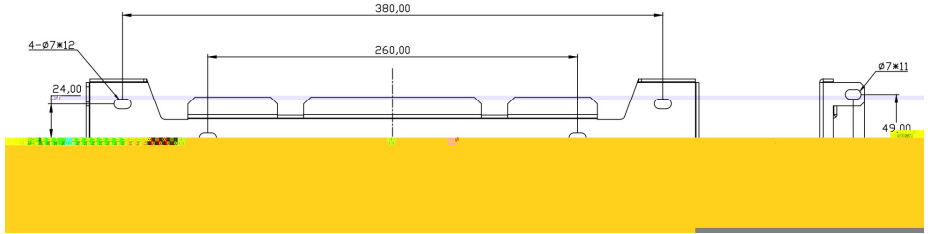

25

1

2

10m

60m

3

26

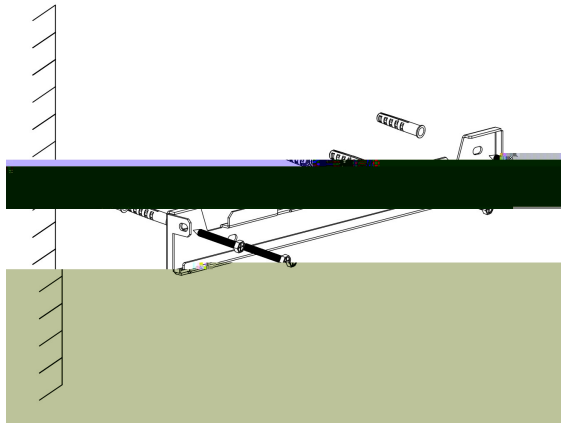

26

4

27

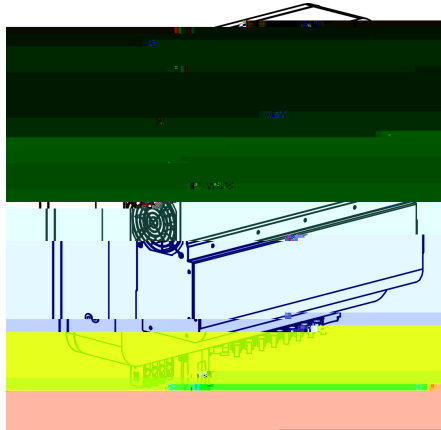

27

5

(28



28

3

31

REG(304)NL4

31

+

-

1 ° “

e

1 K

31 32

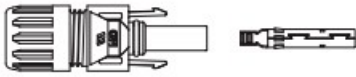

31 (PV)

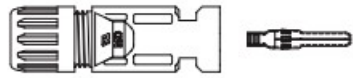

32 (PV)

1

7m

33

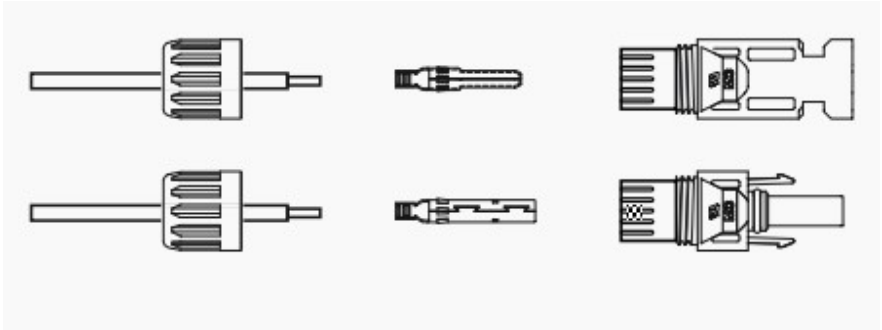

33

2

34

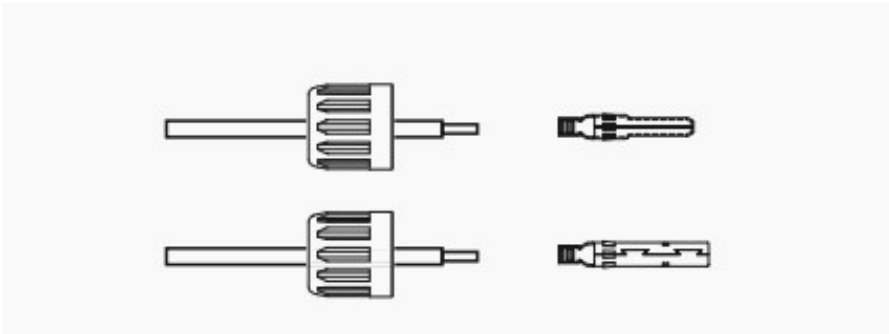

34

3

35

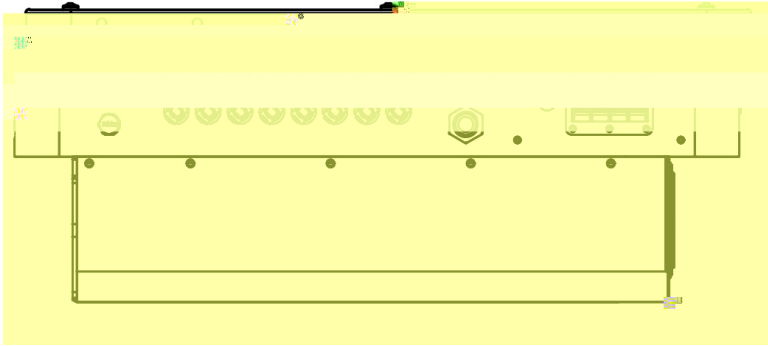

38

	mm		mm
PV-F	40-60 (12-10A)	40 (12A)	55-90

33

KE C(304)KIL4

16 25, 105 C

1.5dm

		/
mmf	16 25	16 25
	16	25



1

90mm

,

39

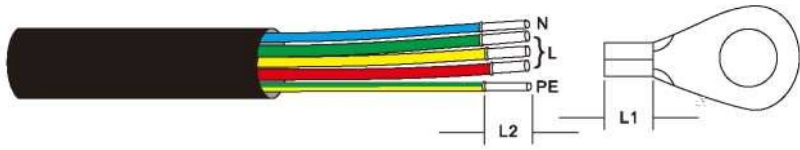

39



2

CT

CT

3

4

3 10 ,

3 11

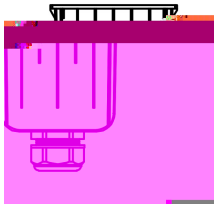

3 10

4

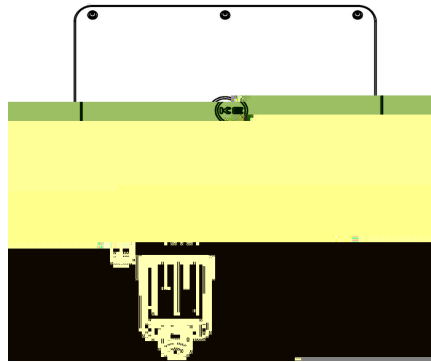

3 11

40Nm

3 12

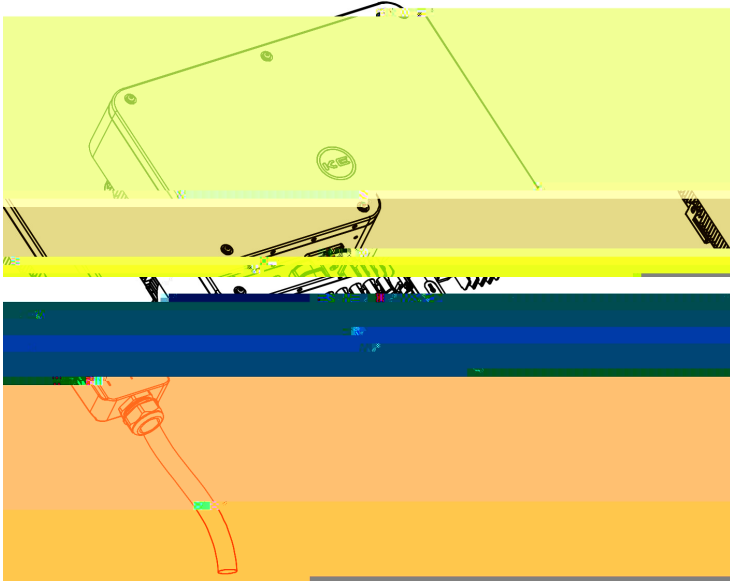

3 12

5

3 4 RS45

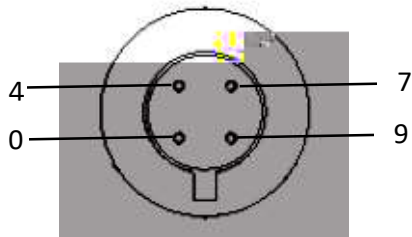

	HN		
RS45_1	2/4	A1 RS45	+
	1/3	A1 RS45	-

3 2

35

1 : 10m

2 CT M6



重要:

对于并联的多个逆变器，所有逆变器应连接到同一接地点，以确保接地线等电位连接。

3

3 14

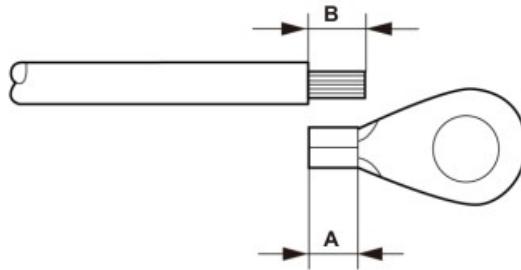

3 14



重要:

P (螺栓总长度) 比A (OT线缆端子压接区域) 长2mm~3mm。

4

CT

3 15

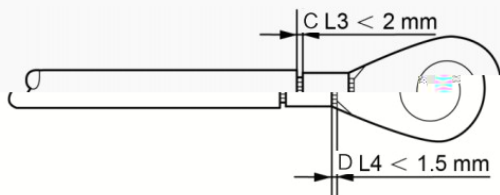

3 15



重要:

将端子压接到导线后，检查连接以确保端子牢固地压到线缆上。

5

6

3 16

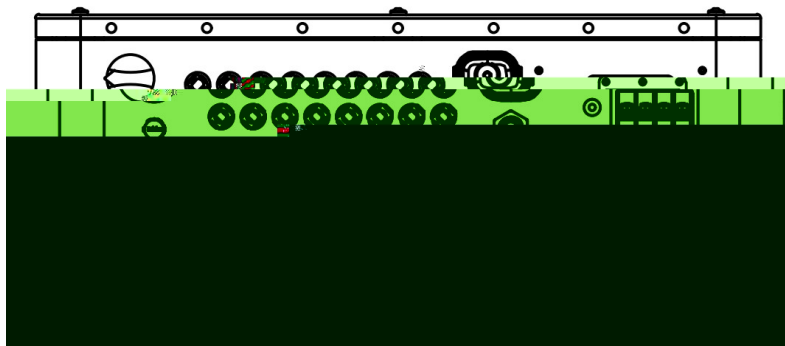

3 16



重要:

为提高防腐性能，安装接地线后，建议涂上硅胶或涂料。

4

41

IE AC
IE AC
AC

42

1
2
3

1
2 30 IED 30

5

5.1

AP



5.1 AP

AP

5.2



5.2

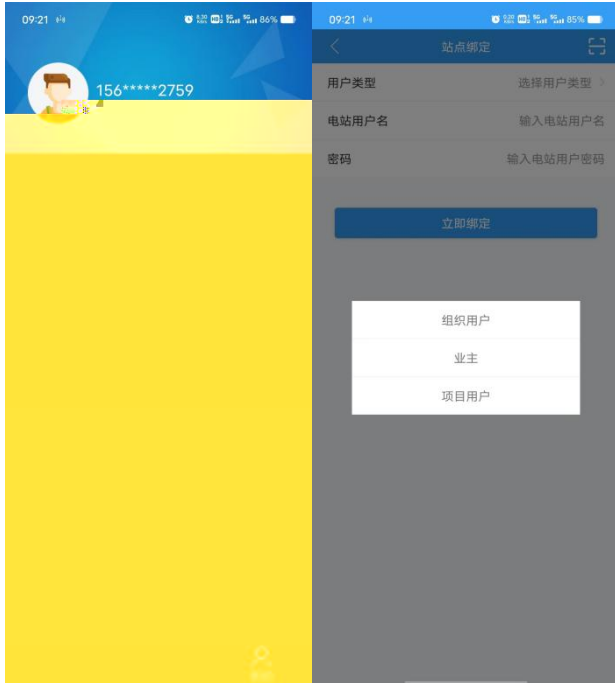

54

52

http://sdlar.ke-energy.com:801/energydoul_sdlar/#/

55

6**61**

	7 4 9
	7 4
	7 4
	7 4 9
	7 4 9
	7 4 9 0

	7 4 9
	7 4
	7 4
	7 4
	7 4 9
	7 4
	7 4
	7 4
	7 4
	7 4

	7
	4

61

7

☞

5

☞

☞

☞

☞

☞

☞

☞

☞

☞

☞

☞

☞

☞

☞

☞

☞

8

- :
- : **0086 311 85231078 400 0811 128**
- : **0086 311 85231087**
- : **[http //www.solarle.com/](http://www.solarle.com/)**